

PROXIMITY INDUCTIVE 8BX

Model:LJ8A3-2-Z/BX



Description:

- Metal shell, DC type, 2mm detecting distance, 3 wire system.
- Power supply inverted connecting protection, short circuit protection, non-contact detecting device.
- When proximity switch is close to some target object, it will send out control signal.
- Used widely in the machine tool industry, frequency counters and other automatic control system.

Specifications:

Product Name	Inductive Proximity Switch
Model	LJ8A3-2-Z/BX
Theory	Inductive Sensor
Wire Type	3 Wire Type (Brown, Blue, Black)
Switch Appearance Type	Cylinder Type, Metal Shell
Output Type	NPN, NO(Normal Open)
Detection Distance	2mm +/- 10%
Electrical Voltage	6-36 V DC
Set Distance	0~1.6mm
Output Current (max)	200mA
Detect objects	Iron
Standard Detection Object	Iron 12x12x1mm
Response Frequency	DC 0.5kHz , AC 25Hz
Column Sensor Diameter	8mm
Thread Diameter	8mm
Total Size	51x8 mm (L * D)
Cable Length	1.24m
External Material	Plastic, Metal
Color	Silver Tone, Gray, Yellow

Dimension	M8
Detection distance	2mm
Dimensional drawing	

Model	DC Type	NPN	NO	LJ8A3-2-Z/BX
			NC	LJ8A3-2-Z/AX
			NO+NC	
		PNP	NO	LJ8A3-2-Z/BY
			NC	LJ8A3-2-Z/AY
			NO+NC	
	Two-wire	NO	LJ8A3-2-Z/EX	
			LJ8A3-2-Z/DX	
		NC	LJ8A3-2-J/EZ	
			LJ8A3-2-J/DZ	
		Three-wire	NO+NC	

Installation:

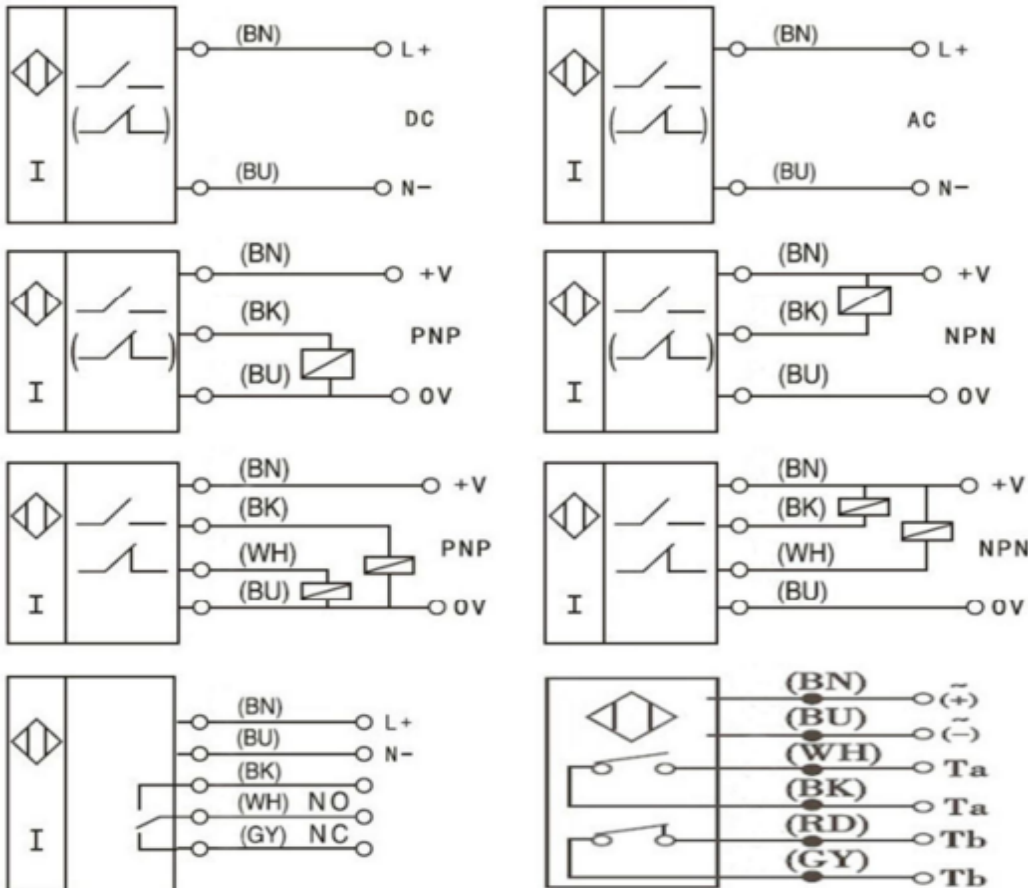

Applications legend:

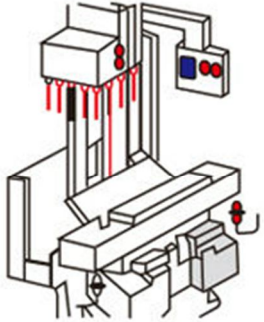
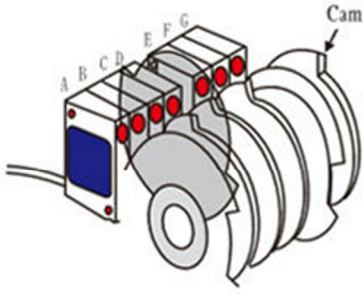
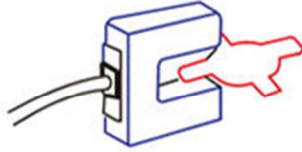
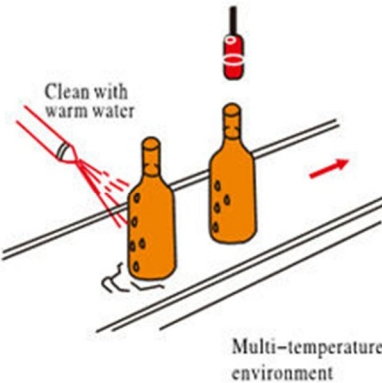
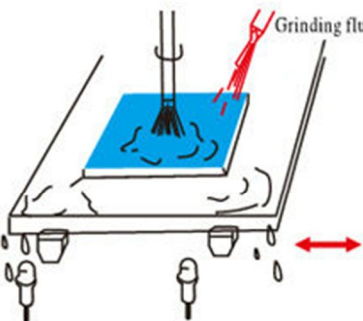
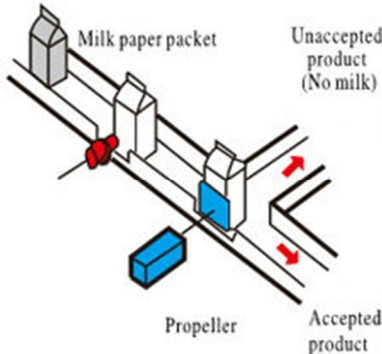
<p>1、Various position detection in machining centre</p>  <p>Cylindrical type proximity switch</p>	<p>2、Action sequence cam detection</p>  <p>Flat type proximity switch</p>	<p>3、Pulser</p>  <p>Slot type proximity switch</p>
<p>4、Bottle cap detection</p>  <p>Clean with warm water</p> <p>Multi-temperature environment</p> <p>Water-proof type proximity switch</p>	<p>5、Grinder stop detection</p>  <p>Grinding fluid</p> <p>Stop</p> <p>Water-proof type proximity switch</p>	<p>6、Detect whether there is milk inside the paper packet</p>  <p>Milk paper packet</p> <p>Unaccepted product (No milk)</p> <p>Propeller</p> <p>Accepted product</p> <p>Capacitive type proximity switch</p>

Made in China